

Universal WIFI external equipment manual

1. Overview of products:

1. Bottom
2. Belt wheel (suit for Belt drive rail)
3. Chain wheel (suit for Chain drive rail)
4. Locking clip (4)
5. WIFI main body, nylon spacer (4), screw (4)
6. Connection cable

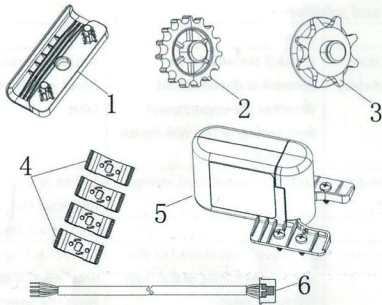

2. Spare parts list for WIFI main body:

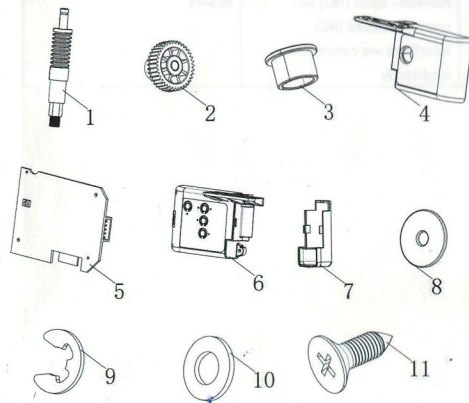

Item	QTY	Description
1	1	Scroll
2	1	Limit gear
3	1	Flange copper sleeve
4	1	Main cover-1
5	1	Circuit board
6	1	Main cover-2
7	1	Main cover-3
8	1	M18 flat gasket
9	1	M5 jump ring
10	1	M5 flat gasket
11	1	M4 screw

3. Parameters:

Input Voltage	DC12-36V/AC12-24V
Working current	20~50mA
The interface state	"NO" or "NC" optional
Radio distance	≤4M
Type of network	2.4GHz frequency band WIFI network
Work temperature	-20°C~50°C

4. Application:

1. The equipment is suitable for rail shape and size as follows (chain drive rail and belt drive rail opening width requirements 28-40mm, opening thickness requirements less than 8.5mm, rail width requirements 60-80mm, rail thickness requirements 25-35mm);

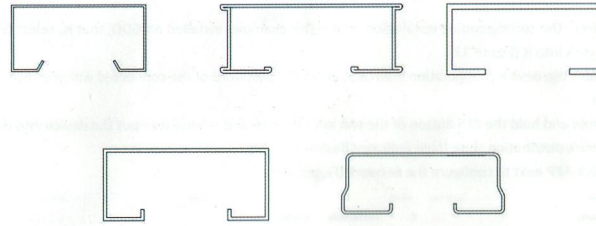

Applicable rail shape (including but not limited to)

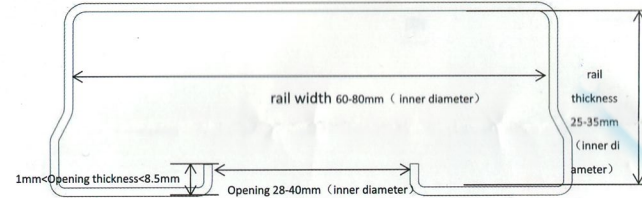

Applicable rail size range

2. The applicable chain and belt dimensions are as follows:

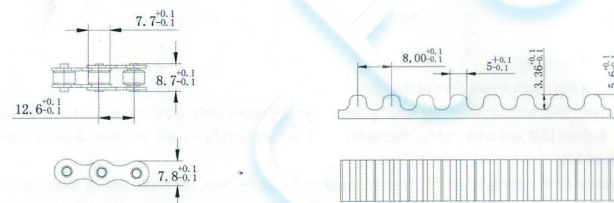

Chain and belt size requirements

5. Installation instruction:

1. Installation steps:

- Step 1: Install the base of the external device into the end of the rail near the motor (Figure 1), and use the edge of the base to hook the left belt or chain inside the rail (Figure 2, 3).

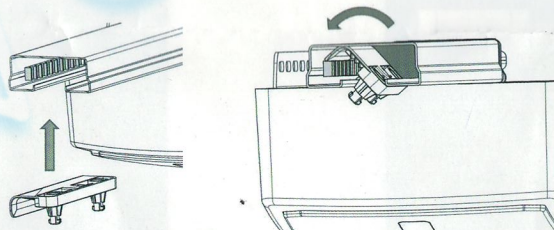

Figure 1

figure 2

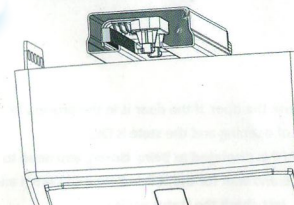

Figure 3

- Step 2: Install the two locking clips parallel to the rails on the corresponding fixed shaft of the base (Figures 4 and 5), and press the clips to rotate 90 degrees in the direction indicated on the clips (Figures 6 and 7)

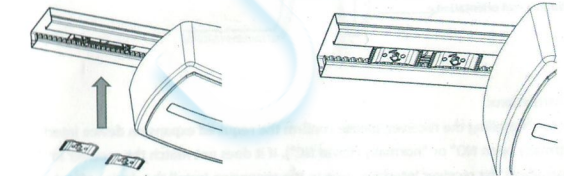

Figure 4

figure 5

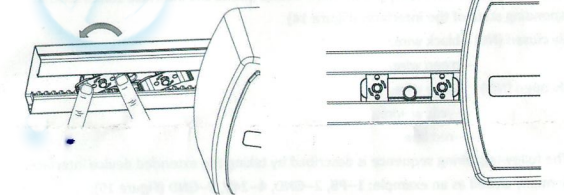

Figure 6

figure 7

- Step 3: Install the corresponding gear into the base (Figure 8 and 9), and ensure that the gear is in good mesh with the belt or chain gear after installation (Figure 10).

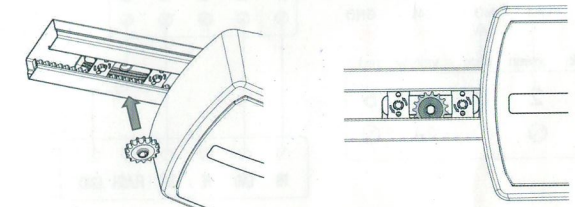

Figure 8

figure 9

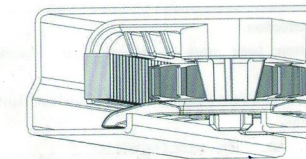

Figure 10

- Step 4: Fix the external device to the two locking clips using the equipped screws as shown in Figures 11, 12, and 13 (note that the flat position of the worm shaft and the flat position of the gear are aligned during installation, and the pretension force is about 1N.M it will damage the clips or the device. If the preload is too small, the device will loosen and follow the belt or chain.)

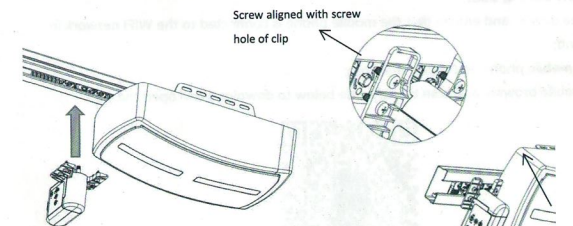
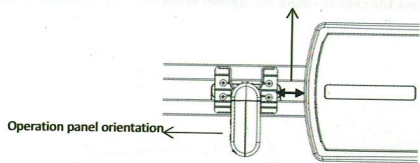

Figure 11

figure 12

Tighten the screw when adjusting the distance to about 5mm



2. Wiring instructions:

Note: Before installing the receiver, please confirm the required expansion device interface status ("normally open NO" or "normally closed NC"). If it does not match the receiver interface state, please adjust the receiver interface state to the expansion. Install the device after the interface status matches. If you do not confirm the interface status, the installation may cause damage to the receiver or the required expansion device due to the interface status mismatch. The corresponding state of the interface: (Figure 14)

- 1--normally closed (NC) --black wire,
- 2--COM --green wire,
- 3--normally open (NO) --blue wire,
- 4--24V --yellow wire,
- 5--GND --red line

Example: The following wiring sequence is described by taking the extended device interface status as normally closed as an example: 1--PB, 2--GND, 4--24V, 5--GND (Figure 15);

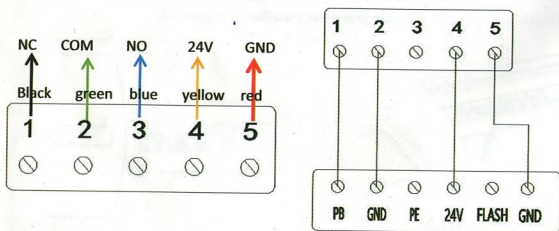
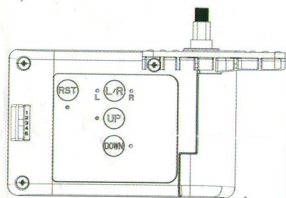

Figure 14

figure 15

6. Operation panel introduction:



Key introduction:
RST button: Long press 5S to enter/exit network button
L/R button: left/right installation settings (default right installation)
UP button: upper limit record setting button
DOWN button: lower limit record setting button
L led light: when the light is on, the device is in the left-mounted setting
R led light: when the light is on, the device is in the right-mounted setting

7. Preparation before use:

1. Power on the device, and ensure that the mobile phone is connected to the WIFI network in the 2.4GHz band;
2. The device, mobile phone and router are close;
3. Open the mobile browser and scan the QR code below to download and open the App:



8. Network access settings:

Note: It needs to operate in the 2.4G network environment, and 5G network is not supported for the time being;

1. Open the "My Home" page of the F-LINX App and click the "+" button in the upper right corner of the page (Figure 16);
2. Select the corresponding installation device (for example: installed on GDO, that is, select GDO) and click into it (Figure 17);
3. Enter the device configuration interface, enter the password of the connected wifi and click Next;
4. Press and hold the RES button of the wifi device for 5S and release it to put the device into the network distribution state (blue indicator flashes quickly);
5. Click APP next to configure the network (Figure 18);

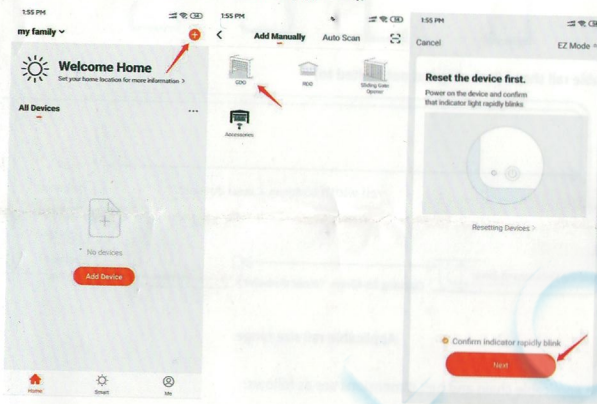

Figure 16

figure 17

figure 18

9. Limit setting:

1. Reset the upper/lower limit of the opener;
2. Upper limit setting: when the door is opened to the upper limit, press the wifi external device UP button LED indicator lights, the upper limit is successfully saved, the APP displays 100% (Figure 19);
3. Lower limit setting: when the door is closed to the lower limit, press the DOWN button of the wifi external device, the LED indicator lights, and the lower limit is successfully saved, the APP displays 0% (Figure 20);

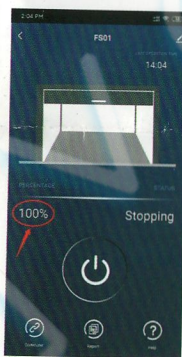

Figure 19

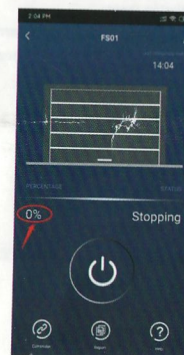

figure 20

10. Status check:

For example: click the APP button to open and close the door. If the door is in the process of opening, then the APP display is also in the state of opening and the state is OK; If the door is in the process of opening, and the APP is displayed as being closed, you need to click the left/right installation button of the device and wait for the LED indicator to switch and then perform the 7-2 and 7-3 setting steps again. Just check the status again;

11. Introduction to APP:

1. New installation equipment and equipment installation location settings can be set in the home interface of the APP, the APP will give you real-time weather information according to the location of the location;
2. Family management can be performed in the APP main interface Me (you can invite others to join your family group, you can also join others' family group), when others join your family, it can control all the devices in your current family group;
3. If you want to let it control only one device in the family group, you need to share the device in the setting function on the upper right of the control interface of the desired sharing device;

12. Common faults and solutions:

Problem	reason	solution
The remote control the door switch, the APP has no display	Check if the wifi device network is disconnected Whether the upper/lower limit setting of the Wifi device is normal	Wifi device reconfiguration Reset wifi device upper/lower limit
The running status of the door does not match the APP display	Left/right installation wrong	Switch left/right installation and reset the upper/lower limit of wifi device
After the door body runs, the stop percentage does not match the door body	The device has moved or the upper/lower limit of the door has been reset.	After checking whether the wifi device is firmly installed, reset the upper/lower limit of the wifi device
APP cannot control the door switch	Check if the wifi device network is disconnected	Wifi device reconfiguration
Wifi device or extension device runs automatically when powered on	Normally open (NO) and normally closed (NC) interfaces are connected incorrectly	Rewire